



Rubber two way wall multi socket

200 250 V ~

16 A

2P + \perp

CODE: 215.116.103

TECHNICAL DETAILS



Designation:	Schuko / German Socket 2P+E
Connection Method:	3 Pole Screw Terminal 16A Max (2,5mm ²) with strain relief angel
Standard:	DIN 49440 1:2006 01
Net Weight:	279gr
Case Cover Plastic Material:	Thermoplastic Elastomer
Contact Contacting Plastic Material:	Copolymer
Cable Holder Plastic Material:	PA6
Screw:	Cq 22
Busbar:	MS 58 Brass

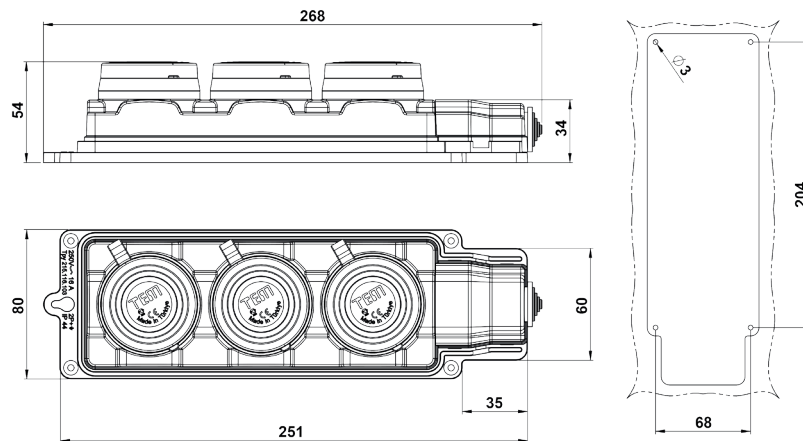

Packing Details:

	Inner Quantity	Dimensions	Gross Weight	CBM
Box	8pcs	24x29x16cm	2.472	3.71
Cardboard	96pcs	58x50x49cm	30.925	47.37